





















More information on the website  
[radwag.com/en/info,w1,90N](http://radwag.com/en/info,w1,90N)

# AS 60/220.X2 PLUS Analytical Balance



## Functions

-  Autotest
-  Dosing
-  Percent Weighing
-  Parts counting
-  Peak hold
-  Formulation
-  Newton unit measurement
-  Statistics
-  Checkweighing
-  IR sensors
-  Under-pan weighing
-  GLP Procedures
-  Animal weighing
-  Density determination
-  Ambient conditions monitoring
-  Replaceable unit
-  ALIBI Memory
-  Mass for titrator
-  Wi-Fi

## Datasheet

| Metrological parameters |               |
|-------------------------|---------------|
| Maximum capacity [Max]  | 60 / 220 g    |
| Minimum load            | 1 mg          |
| Readability [d]         | 0,01 / 0,1 mg |
| Tare range              | -220 g        |

| <b>Metrological parameters</b>      |  |
|-------------------------------------|--|
| Linearity                           | ±0,05/0,2 mg   |
| Stabilization time                  | 2 s  |
| Adjustment                          | internal (automatic)                                     |
| OIML Class                          | I  |
| Standard repeatability [5% Max]     | 0,01 mg  |
| Standard repeatability [Max]        | 0,06 mg  |
| Standard minimum weight (USP)       | 20 mg  |
| Standard minimum weight (U=1%, k=2) | 2 mg   |
| Permissible repeatability [5% Max]  | 0,02 mg  |
| Permissible repeatability [Max]     | 0,1 mg   |
| <b>Physical parameters</b>          |  |
| Display                             | 5" capacitive colour touchscreen                         |
| Weighing chamber dimensions         | 190×190×222 mm   |
| Weighing pan dimensions             | ø90 + ø85 (option) mm                                    |
| Packaging dimensions                | 495×400×515 mm   |
| Net weight                          | 7,3 kg   |
| Gross weight                        | 9,3 kg   |
| <b>Features of use</b>              |  |
| Database capacity                   | 7  |
| Touch-free operation                | 2 IR Sensors   |
| <b>Communication interface</b>      |  |
| Communication interface             | RS232, 2×USB-A (interchangeable), USB-B, Wi-Fi, Ethernet |
| <b>Electrical parameters</b>        |  |
| Power supply                        | 100 ÷ 240 V AC 50 / 60 Hz                                |
| Power consumption max.              | 4 W  |
| <b>Environmental conditions</b>     |  |
| Operating temperature               | +10 ÷ +40 °C   |
| Relative humidity                   | 40% ÷ 80%  |

\* Wi-Fi® is a registered trademark of Wi-Fi® Alliance.



## Accessories

Receipt Printer  
 Granite Antivibration Tables  
 Holders for laboratory flasks  
 Barcode scanners  
 Cigarette lighter receptacle power supply cables  
 Density determination kit  
 Power Adapters  
 USB cable (scale - printer)  
 Professional weighing table

Holders for test tubes and filters  
 Workstation for Pipettes Calibration  
 Displays  
 Protective cover for balances  
 Antistatic ionizer  
 RS 232, RS 485 cables  
 Under-Pan Weighing Rack  
 RS 232 cables (scale - EPSON printer)

# Software

RAD-KEY  
RADWAG Connect  
R-LAB  
E2R System

LabVIEW Driver  
ALIBI Reader  
RADWAG Development Studio  
R.Barcode

# Device dimensions

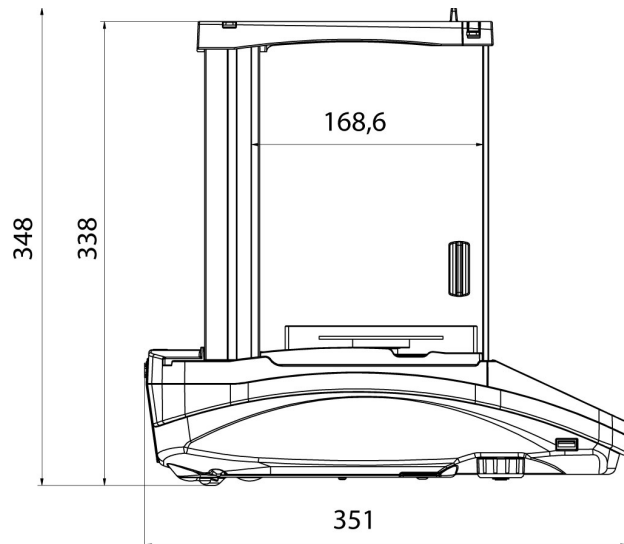
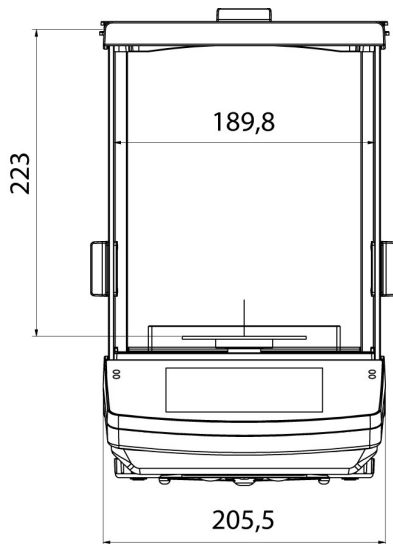

AS X2 PLUS, d = 0.01 mg

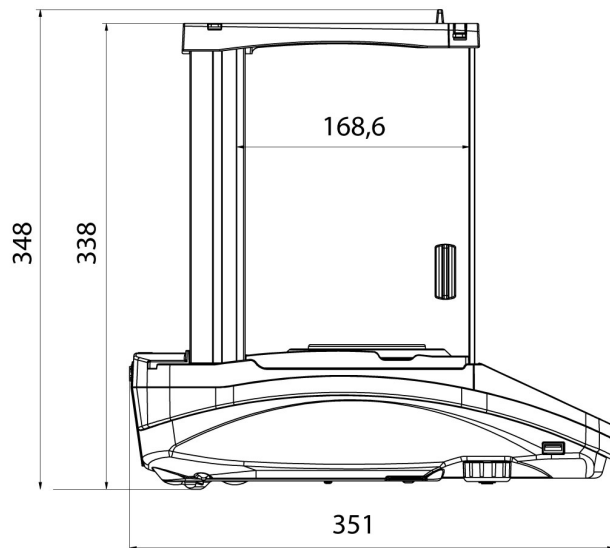
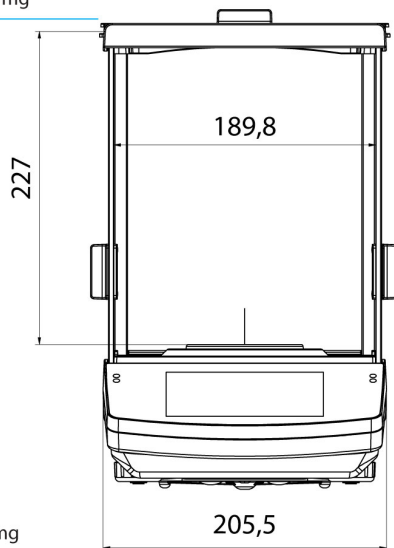

AS X2 PLUS, d = 0.1 mg