

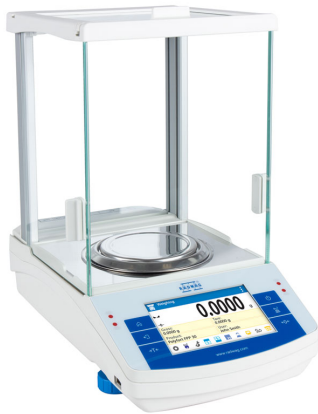

AS 310.X2 PLUS Analytical Balance





















More information on the website
radwag.com/en/info,w1,X8U



AS 310.X2 PLUS Analytical Balance

The drawings, photos and graphics used are for illustrative purposes only.

Functions

- | | | | |
|---|---|---|--|
|  Autotest |  Dosing |  Percent Weighing |  Parts counting |
|  Peak hold |  Formulation |  Newton unit measurement |  Statistics |
|  Checkweighing |  IR sensors |  Under-pan weighing |  GLP Procedures |
|  Animal weighing |  Density determination |  Ambient conditions monitoring |  Replaceable unit |
|  Statistical Quality Control |  ALIBI Memory |  Mass for titrator |  Wi-Fi |

Datasheet

AS 310.X2 PLUS Analytical Balance	
Metrological parameters	
Maximum capacity [Max]	310 g
Minimum load	10 mg
Readability [d]	0,1 mg
Verification scale interval [e]	1 mg
Tare range	-310 g
Standard repeatability [5% Max]	0,07 mg
Standard repeatability [Max]	0,1 mg
Standard minimum weight (USP)	140 mg
Standard minimum weight (U=1%, k=2)	14 mg
Permissible repeatability [5% Max]	0,12 mg
Permissible repeatability [Max]	0,15 mg
Linearity	±0,2 mg
Stabilization time	2,5 s
Adjustment	internal (automatic)
OIML Class	I
Physical parameters	
Leveling system	manual
Display	5" graphic color touchscreen
Protection class	IP 43
Delivery components	Balance, weighing pan, weighing pan shield, bottom cover, power supply.
Weighing chamber dimensions	190×190×222 mm
Weighing pan dimensions	ø100 mm
Packaging dimensions	495×400×515 mm
Net weight	7,3 kg
Gross weight	9,3 kg
Features of use	
Database capacity	7
Touch-free operation	2 IR Sensors
Communication interface	
Communication interface	RS232, 2×USB-A (interchangeable), USB-B, Wi-Fi, Ethernet
Electrical parameters	
Power supply	Adapter: 100 – 240V AC 50/60Hz 0,6A; 12V DC 1,2A Balance: 12 – 15V DC 0,8A max
Power consumption max.	4 W
Environmental conditions	
Operating temperature	+10 ÷ +40 °C
Relative humidity	40% ÷ 80%

Repeatability is expressed as a standard deviation from 10 weighing cycles. Stabilization time depends on the ambient conditions and the dynamics of weighing pan loading; specified for FAST profile. 1 Barcode scanners, available as weighing instrument accessory, communicate with the instrument via RS232 interface exclusively.

* Wi-Fi® is a registered trademark of Wi-Fi® Alliance.



Accessories

Antivibration Tables
Holders for laboratory flasks
Barcode scanners
Cigarette lighter receptacle power supply cables
Density determination KIT
USB cable (scale - printer)
Professional weighing table
Holders for test tubes and filters
Workstation for Pipettes Calibration

Power Adapters
Displays
Protective cover for balances
Weighing dishes
Antistatic ionizer
Receipt Printer
RS 232, RS 485 cables
Under-Pan Weighing Rack
RS 232 cables (scale - printer)

Software

RAD-KEY
Alibi Reader
RADWAG Development Studio
R.Barcode

LabVIEW Driver
R-LAB
E2R System

Device dimensions

AS 310.X2 PLUS Analytical Balance

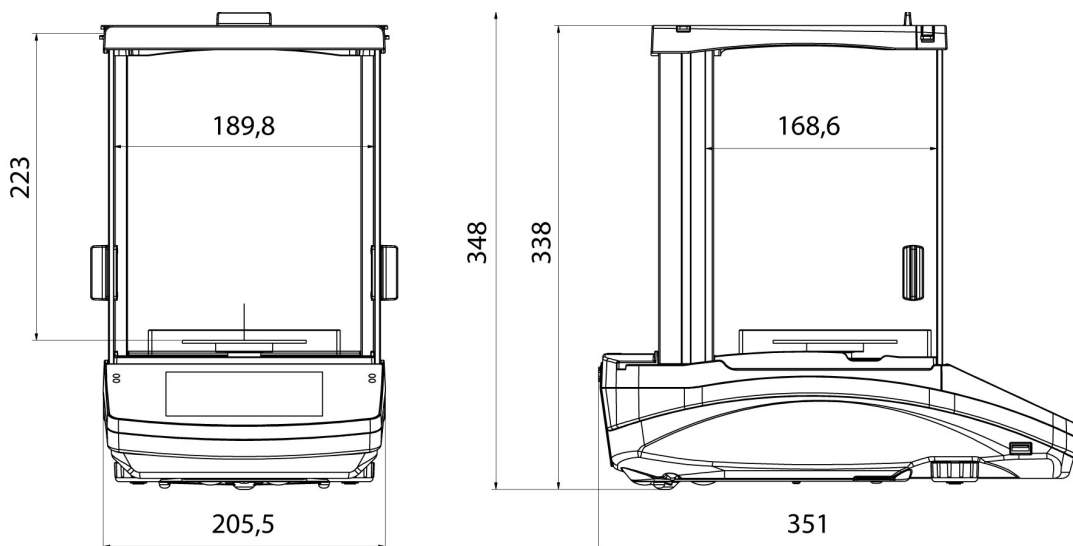

AS X2 PLUS, d = 0.01 mg

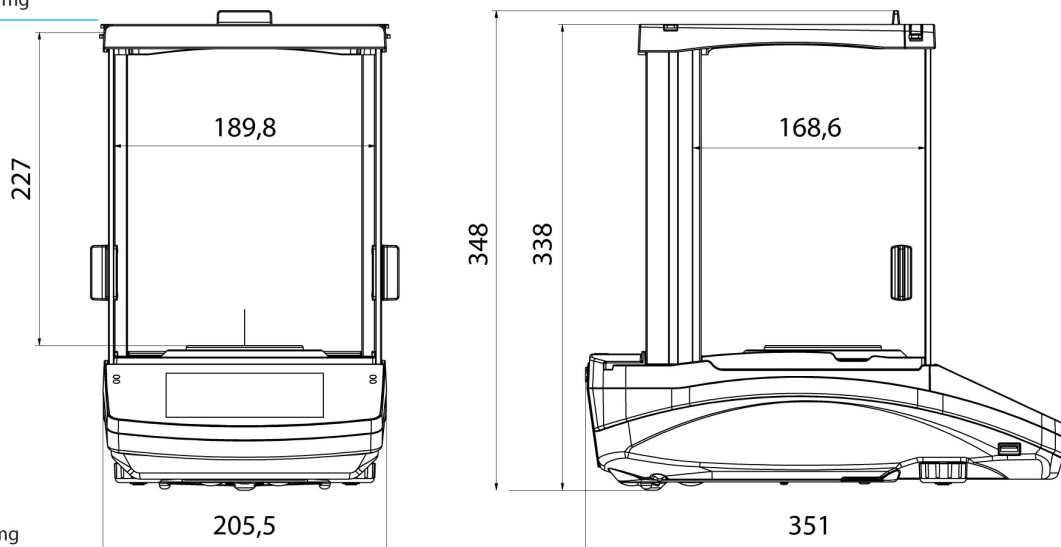

AS X2 PLUS, d = 0.1 mg